

the Baker's Dozen™

Instruction Book - LBM250



Breville®



Contents

- 2 Breville Recommends Safety First
- 6 Components
- 8 Operating your Bread Maker
- 14 Hints & Tips for
Better Bread Making
- 17 Care, Cleaning & Storage
- 19 Recipes
- 25 Troubleshooting

BREVILLE RECOMMENDS SAFETY FIRST

At Breville we are very safety conscious. We design and manufacture consumer products with the safety of you, our valued customer, foremost in mind. In addition, we ask that you exercise a degree of care when using any electrical appliance and adhere to the following precautions.

IMPORTANT SAFEGUARDS

READ ALL INSTRUCTIONS BEFORE USE AND SAVE FOR FUTURE REFERENCE

- Remove and safely discard any packaging material and promotional labels before using the bread maker for the first time.
- To eliminate a choking hazard for young children, remove and safely discard the protective cover fitted to the power plug of this bread maker.
- Do not place the bread maker near the edge of a bench or table during operation. Ensure the surface is level, clean and free of water, flour and other substances. Vibration during the kneading cycles may cause the machine to move slightly.
- Do not place this bread maker on or near a hot gas or electric burner, or where it could touch a heated oven. Position the bread maker at a minimum distance of 20cm away from walls. This will help prevent the possibility of discolouration due to radiated heat.

- Always operate the bread maker on a stable and heat resistant surface. Do not use on a cloth-covered surface, near curtains or other flammable materials.
- Do not operate the bread maker on a sink drain board.
- Always ensure the bread maker is properly assembled before connecting to a power outlet and operating. Follow the instructions provided in this book.
- The bread maker is not intended to be operated by means of an external timer or separate remote control system.
- The lid and the outer surface may get hot when the bread maker is operating.
- The temperature of accessible surfaces may be high when the bread maker is operating.
- Do not touch hot surfaces. Allow the bread maker to cool before cleaning any parts.
- Steam vents are very hot during baking. Do not place anything on top of the lid.
- Do not cover the air vents when the bread maker is in use.
- Always place the ingredients into the bread pan in the precise order listed in the recipe. Not doing so may cause the ingredients to fail to incorporate properly for a poor result.
- Use oven mitts when removing the hot bread or any contents from the pan.
- Take care when pouring jam from the bread pan as the jam will be extremely hot.
- Do not place any ingredients directly into the baking chamber. Place ingredients into the bread pan or fruit and nut dispenser only.
- The maximum quantities of flour and raising agent that may be used shall not exceed the quantities stated in the Recipes.
- Do not pour liquids into the fruit and nut dispenser. Do not overpack the fruit and nut dispenser as this may cause them to compact and they may not drop.
- Do not place fingers or hands inside the bread maker during operation. Avoid contact with moving parts.
- Ensure the bread maker is switched off and then unplugged from the power outlet when not in use and before cleaning.

- Do not immerse the bread pan in water. Doing so may interfere with the free movement of the drive shaft. Wash only the interior of the bread pan.
- Do not leave the lid standing open for extended periods of time.
- Always ensure the kneading blade is removed from the base of the baked loaf prior to slicing.
- Do not place the bread maker in direct sunlight. Colour fading and discolouration may occur when the bread maker is consistently exposed to UV light.
- Keep the inside and outside of the bread maker clean. Follow the cleaning instructions provided in this book.
- Do not let the power cord hang over the edge of a bench or table, touch hot surfaces or become knotted.
- To protect against electric shock, do not immerse the power cord, power plug or bread maker in water or any other liquid.
- The bread maker is not intended for use by persons (including children) with reduced physical, sensory or mental capabilities, or lack of experience and knowledge, unless they have been given supervision or instruction concerning use of the bread maker, by a person responsible for their safety.
- Children should be supervised to ensure that they do not play with the bread maker.
- It is recommended to inspect the bread maker regularly. Do not use the bread maker if the power supply cord, plug, connector or bread maker becomes damaged in anyway.
- Return the entire bread maker to the nearest authorised Breville Service Centre for examination and/or repair.
- Any maintenance other than cleaning should be performed at an authorised Breville Service Centre.

IMPORTANT SAFEGUARDS FOR ALL ELECTRICAL APPLIANCES

- Fully unwind the power cord before use.
- Connect only to 230V or 240V power outlet.

- This bread maker is for household use only. Do not use this bread maker for other than its intended use. Do not use in moving vehicles or boats. Do not use outdoors. **Misuse may cause injury.**
- The installation of a residual current device (safety switch) is recommended to provide additional safety protection when using electrical bread makers. It is advisable that a safety switch with a rated residual operating current not exceeding 30mA be installed in the electrical circuit supplying the bread maker. See your electrician for professional advice.
- During electrical storms, the bread maker should be disconnected from the power source at the wall socket to prevent any electrical surges that may arise during the storm and which may inadvertently cause damage to the bread maker and its electronic componentry.
- Always turn the bread maker to the OFF position, switch off at the power outlet and unplug at the power outlet when the bread maker is not in use.
- Before cleaning, always turn the bread maker to the OFF position, switch off at the power outlet, unplug at the power outlet and remove the power cord, if detachable, from the bread maker and allow all parts to cool.
- Do not place this bread maker on or near a heat source, such as hot plate, oven or heaters.
- Position the bread maker at a minimum distance of 20cm away from walls, curtains and other heat or steam sensitive materials and provide adequate space above and on all sides for air circulation.



WARNING

Food particles on the heating element in the baking chamber may cause smoke to emanate from the bread maker. Ensure the baking chamber is clean before use.



WARNING

Steam vents are very hot during baking.

**FOR HOUSEHOLD USE ONLY
SAVE THESE INSTRUCTIONS**

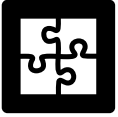

Components

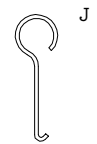
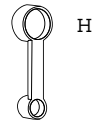
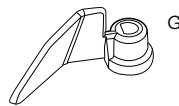
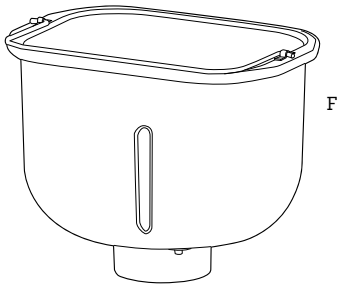
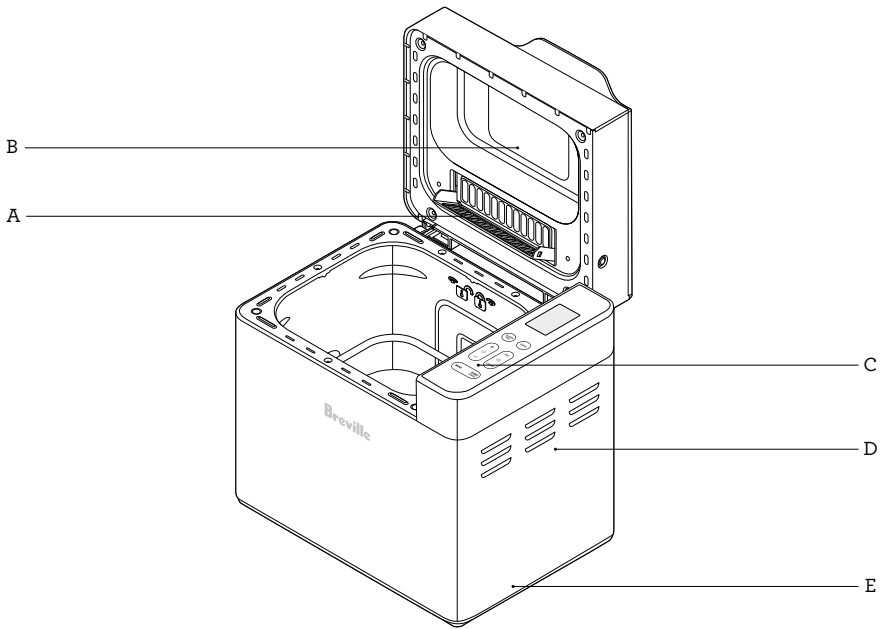

A. Lid with Fruit and Nut Dispenser

B. Viewing Window

C. Control Panel

D. Bread Maker Housing

E. Base

F. Bread Pan

G. Kneading Blade

H. Measuring Spoon

I. Measuring Cup

J. Kneading Blade Hook

Not Shown

- Non-slip Feet for Stability
- Drive Shaft
- Power Cord

CONTROL PANEL

A. ILLUMINATED DISPLAY SCREEN

The LCD display indicates the menus and settings selected.

B. DOUGH BUTTON SHORTCUT

Press to go directly to the dough function.

C. GLUTEN FREE BUTTON SHORTCUT

Press to go directly to the gluten free bread function.

D. LOAF SIZE SELECTOR

E. DELAY START TIMER

Press + or - to increase or decrease start time.

F. CRUST COLOUR SELECTOR

G. MENU

In standby mode, pressing the MENU button will cycle through the menu options.

1. Basic
2. French
3. Whole Wheat
4. Sweet
5. Express 680g
6. Express 900g
7. Yeast Free
8. Continental
9. Dough
10. Gluten Free
11. Jam
12. Bake
13. Yoghurt

H. START/CANCEL

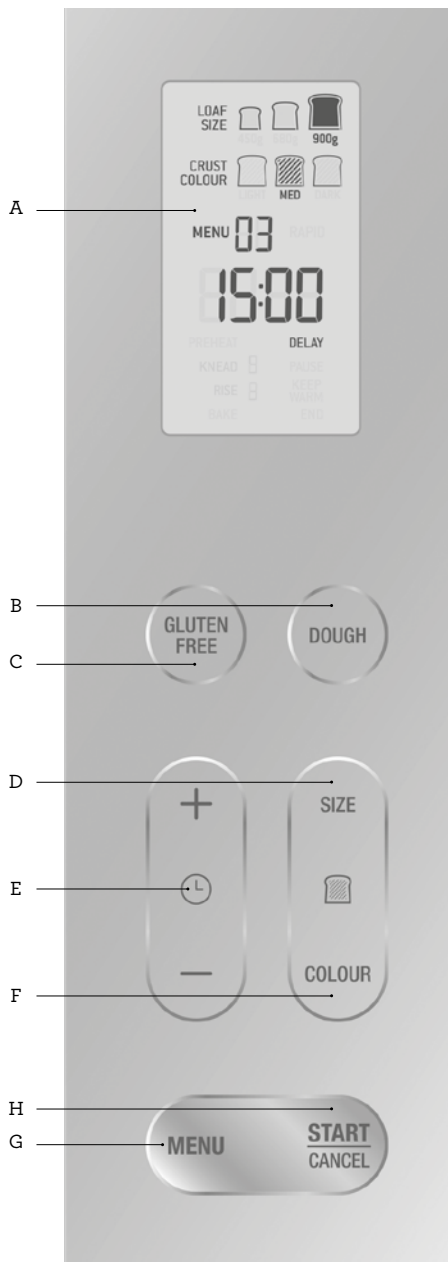



Operating Your Bread Maker

BREAD, DOUGH, YOGHURT & JAM SETTINGS

SETTINGS	CRUST COLOUR	LOAF SIZE	TOTAL TIME
BASIC	LIGHT	450g	3 hours 13 mins
	LIGHT	680g	3 hours 18 mins
	LIGHT	900g	3 hours 25 mins
	MEDIUM	450g	3 hours 13 mins
	MEDIUM	680g	3 hours 18 mins
	MEDIUM	900g	3 hours 25 mins
	DARK	450g	3 hours 13 mins
	DARK	680g	3 hours 18 mins
	DARK	900g	3 hours 25 mins
	RAPID	450g	2 hours 12 mins
	RAPID	680g	2 hours 17 mins
	RAPID	900g	2 hours 24 mins
FRENCH	LIGHT	450g	3 hours 30 mins
	LIGHT	680g	3 hours 35 mins
	LIGHT	900g	3 hours 40 mins
	MEDIUM	450g	3 hours 30 mins
	MEDIUM	680g	3 hours 35 mins
	MEDIUM	900g	3 hours 40 mins
	DARK	450g	3 hours 30 mins
	DARK	680g	3 hours 35 mins
	DARK	900g	3 hours 40 mins
	RAPID	450g	2 hours 30 mins
	RAPID	680g	2 hours 35 mins
	RAPID	900g	2 hours 40 mins
WHOLE WHEAT	LIGHT	450g	3 hours 45 mins
	LIGHT	680g	3 hours 50 mins
	LIGHT	900g	3 hours 55 mins
	MEDIUM	450g	3 hours 45 mins
	MEDIUM	680g	3 hours 50 mins
	MEDIUM	900g	3 hours 55 mins
	DARK	450g	3 hours 45 mins
	DARK	680g	3 hours 50 mins
	DARK	900g	3 hours 55 mins
	RAPID	450g	2 hours 30 mins
	RAPID	680g	2 hours 35 mins
	RAPID	900g	2 hours 40 mins

SETTINGS	CRUST COLOUR	LOAF SIZE	TOTAL TIME
SWEET	LIGHT	450g	3 hours 17 mins
	LIGHT	680g	3 hours 22 mins
	LIGHT	900g	3 hours 27 mins
	MEDIUM	450g	3 hours 17 mins
	MEDIUM	680g	3 hours 22 mins
	MEDIUM	900g	3 hours 27 mins
	DARK	450g	3 hours 17 mins
	DARK	680g	3 hours 22 mins
	DARK	900g	3 hours 27 mins
	RAPID	450g	2 hours 37 mins
	RAPID	680g	2 hours 42 mins
	RAPID	900g	2 hours 47 mins
EXPRESS 680G		680g	1 hour 20 mins
EXPRESS 900G		900g	1 hour 55 mins
YEAST FREE			1 hour 50 mins
CONTINENTAL DOUGH			3 hours 25 mins
DOUGH			1 hour 30 mins
GLUTEN FREE			2 hours 45 mins
JAM			1 hour 05 mins
BAKE			5 mins to 1 hour 30 mins
YOGHURT			4 hours to 12 hours



NOTE

Total times for the bread functions do not include the Keep Warm time.



Functions

BEFORE FIRST USE

Before first use, remove and safely discard any packing material, promotional labels, transparent protective film on the control panel and tape from the bread maker. Check for any missing or damaged parts. Clean all parts according to the Care, Cleaning & Storage section in this book.

OPERATING YOUR BREVILLE BREAD MAKER

1. Open the lid of the bread maker and remove the bread pan using the handle.
2. If required, align the groove on the top of the kneading blade to the one on top of the drive shaft and slide the blade down onto the drive shaft, in the bread pan.

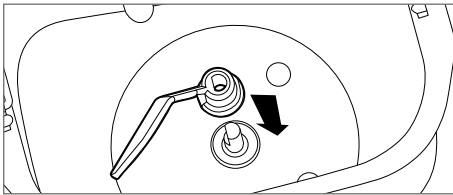

3. Add ingredients to the bread pan in the order listed in the recipe. First add liquids, fats, salt, sugar and add the yeast in last.

IMPORTANT

Ensure all ingredients for making bread or dough are added in the exact order listed. Failing to do so may lead to a poor result and/or ingredients being expelled out of the bread pan.

NOTE

Ensure yeast does not come into contact with sugars, salt or liquid.

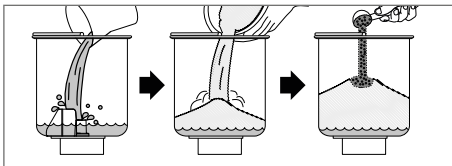

NOTE

If using the delay start timer, make sure the yeast is on top of the dry ingredients to avoid contact with water, salt and sugar, otherwise the yeast activity will be affected.

4. Lock the bread pan into the base of the bread maker by twisting slightly clockwise until the bowl sits horizontal.
5. Fold the handle down and close the lid.

NOTE

The bread pan is locked in place correctly if you cannot lift it from the bread maker without twisting.

6. If fruits and/or nuts are required press and hold the latch upwards under the handle of the dispenser holder located on the rear of the lid. Pull out the dispenser holder and add ingredients before closing the dispenser.
7. Plug the bread maker into a 220-240V power outlet and switch the outlet on. The bread maker is now in standby mode and the display screen will illuminate for 1 minute.

NOTE

In standby mode, the LCD screen will show the first MENU selection Basic Bread, displaying MENU 1 900g MEDIUM TIMER 3:25. Press the MENU button repeatedly to cycle through the MENU choices 1-13.

Menu Selection	Menu No.	Display Screen Default Reading			Able to adjust defaults
		Time	Crust Colour	Loaf Size	
Basic	1	3:25	Medium	900g	YES
French	2	3:40	Medium	900g	YES
Whole Wheat	3	3:55	Medium	900g	YES
Sweet	4	3:27	Medium	900g	YES
Express 680g	5	1:20	N/A	N/A	NO
Express 900g	6	1:55	N/A	N/A	NO
Yeast Free	7	1:50	N/A	N/A	NO
Continental	8	3:25	N/A	N/A	YES
Dough	9	1:30	N/A	N/A	NO
Gluten Free	10	2:45	N/A	N/A	NO
Jam	11	1:05	N/A	N/A	NO
Bake	12	1:00	N/A	N/A	YES
Yoghurt	13	8:00	N/A	N/A	YES

BREAD MAKING

- Follow steps 1 to 7 on page 9 to set up the bread maker.
- Press the MENU button until the preferred menu number is displayed on the LCD screen.
- To change the crust colour, press the COLOUR button to cycle through Light, Medium, Dark (and Rapid) shown on the LCD screen.
- To change the loaf size, press the SIZE button to cycle through 450g, 680g or 900g shown on the LCD screen.
- Press the START/CANCEL button, when selections are complete, to begin the cycle.



NOTE

Press any button except the START/CANCEL button during operation to illuminate the LCD screen for 1 minute.

Press the START/CANCEL button once during operation to PAUSE the bread maker.



NOTE

5 beeps will sound after the knead 6 stage of BASIC, FRENCH, WHOLE WHEAT, SWEET and CONTINENTAL settings. At this point, if preferred, use the pause function to remove the kneading blade before recommencing.

- To cancel the cycle, press and hold the START/CANCEL button for 3 seconds during operation. The bread maker will emit a long beep tone and return to standby mode.

PAUSE

The PAUSE function can be used at anytime during operation, to scrape the bread pan sides down, remove the kneading blade or to add ingredients.

- Press the START/CANCEL button once to PAUSE the bread maker.



NOTE

The LCD screen will display a flashing PAUSE and the bread maker will beep 5 times every 30 seconds for the duration of 10 minutes before resuming operation.

- Press the START/CANCEL button again to resume operation.



NOTE

The bread maker will remain in PAUSE mode for 10 minutes before resuming operation if it has not been cancelled.



NOTE

The pause function can be selected at anytime during operation except the KEEP WARM phase.

RAPID

The RAPID bread selection makes a loaf of bread in less time and is available on BASIC, WHOLE WHEAT, FRENCH and SWEET bread menus. Selecting Rapid will bake a bread loaf to a medium crust colour and reduce the finishing time by about an hour. To select, press the CRUST COLOUR button to cycle through until RAPID is displayed. (See BREAD, DOUGH, YOGHURT & JAM SETTINGS table on page 8 for setting details).



NOTE

When using the RAPID option, increase the yeast content by 1/4 teaspoon or Surebake by 1 teaspoon.

DELAY START TIMER

1. If desired, press the + or - TIMER button to change the start time on the bread maker.
2. The time displayed represents the finishing time. For example, if you adjust the Basic Bread default time 3:25 to 5:00, the bread will be finished at the end of 5 hours. The time can be delayed by up to 15 hours.



NOTE

The Crust Colour, Loaf Size and Timer can only be adjusted on MENU selections 1-4. Selection 8 allows for the timer to be adjusted only. All other menu selections operate as per their default setting. See MENU Default Table on page 10.



NOTE

If the Timer is activated, the kneading blade will not mix the ingredients until the cycle is set to begin. For example, for Basic Bread the default time to complete the program is 3:25. If the delayed time is changed to 5:00, the cycle will not start for 1hr 35 minutes after pressing START/CANCEL button.



WARNING

Do not touch the moving parts in the bread maker while the machine is working.

3. Once the baking phase is complete, the bread maker will beep 10 times and switch to the Keep Warm function for 1 hour. Press and hold START/CANCEL button for 3 seconds to cancel the Keep Warm function and return to standby mode.
4. After 1 hour on the Keep Warm function, the bread maker will beep 10 times, the LCD screen will display a flashing END for one minute and return to standby mode.

5. Let the bread pan cool down slightly before removing. Use oven mitts to lift the handle, and carefully twist and lift to remove the bread pan from the bread maker.
6. To remove the bread loaf, turn the bread pan upside down on a clean surface and lightly shake until the loaf falls out. Place onto a wire cooling rack to prevent a soggy bread base.
7. Allow bread to cool for at least 10 minutes.
8. Remove the kneading blade from the base of the bread by using the kneading blade hook supplied. Hook into the groove in the centre of the kneading blade, and carefully pull the kneading blade out from the bottom of the bread.



WARNING

During the kneading cycle, the bread maker may wobble and move slightly.



WARNING

Both the bread pan and baking chamber will be hot - oven mitts should be used. Use the handle to remove the bread pan from the baking chamber.



NOTE

Allow the bread to cool before slicing to produce clean, neat slices.



WARNING

Remove the kneading blade from the bread using the kneading blade hook before slicing.



NOTE

Once the bread has cooled, store remaining bread in a sealed plastic bag for up to 2 days at room temperature. To store for a longer time, place sealed plastic bag in the refrigerator for up to 5 days.

DOUGH MAKING FUNCTION

1. Press the DOUGH button shortcut on the control panel. MENU setting 9 will display on the LCD screen.
2. Press the START/CANCEL button to begin.



NOTE

Dough making is similar to the bread making but without heating/baking.

Dough making function can also be selected by pressing MENU button until DOUGH setting 9 is displayed on the LCD screen.

GLUTEN FREE

1. Press the GLUTEN FREE button shortcut on the control panel. MENU setting 10 will display on the LCD screen.
2. Press the START/CANCEL button to begin.



NOTE

Gluten Free can also be selected by pressing MENU until GLUTEN FREE setting 10 is displayed on the LCD screen.

JAM MAKING FUNCTION

1. After fitting the bread pan with the kneading blade, add the ingredients to the bread pan. Twist and lock the bread pan into the bread maker.
2. Press the MENU button until JAM setting 11 is displayed on the LCD screen.
3. Press the START/CANCEL button to commence.
4. Store in sterilized jars.



NOTE

The JAM function is ideal for making sweet jams from fresh fruits.

When using the JAM function, cut fresh fruit into 1cm pieces before adding into the bread pan.

Use no more than 2 cups of ingredients as the maximum amount for the JAM function. Avoid high liquid food such as tomatoes.

BAKE

The BAKE setting is a good menu selection to add baking time for a darker, crisper crust.

The BAKE function can also be used to bake cakes and to crispen and re-warm pre-baked loaves.

1. Press the MENU button until BAKE setting 12 is displayed on the LCD screen.
2. Press + or - TIMER button to change the BAKE time. Baking time can be adjusted between 5 minutes (0:05) to 1 hour 30 minutes (1:30).
3. Press the START/CANCEL button to begin.



NOTE

Bake and yoghurt are the only Menu selections that do not require the kneading blade to be inserted into the bread pan.

YOGHURT FUNCTION

The YOGHURT function works by heating the yoghurt ingredients at a constant low temperature for a long period of time.

1. Press the MENU button until YOGHURT setting 13 is displayed on the LCD screen.
2. Press + or - TIMER button to adjust the YOGHURT time. YOGHURT time can be adjusted between 4 to 12 hours.
3. Press the START/CANCEL button to begin.

FRUIT & NUT DISPENSER

The automatic Fruit and Nut Dispenser releases fruits, nuts, seeds or other suitable ingredients into the dough at a specific time during the 'knead' phase. If added before this time, excessive kneading may cause the ingredients to break down rather than maintain their shape.

1. Ensure that the bread ingredients are placed in the bread pan and the bread pan is fitted properly in the bread maker prior to adding fruit and/or nuts to the fruit and nut dispenser to avoid risk of ingredients falling into the baking chamber.
2. Press and hold the latch upwards under the handle of the dispenser holder located on the rear of the lid. Pull out the dispenser holder and touch the base of the dispenser to check that it is completely closed before adding a maximum $\frac{2}{3}$ cup of dry ingredients. If the base is open, see the troubleshooting section in this book.
3. Add the ingredients into the Fruit and Nut dispenser, before replacing the dispenser back into the machine, also noting:
 - Ingredients should be sized between 0.5cm and 1cm so they do not fall through the steam vents at the base of the dispenser. We recommend separating ingredients that may stick together, such as raisins and other fruits, before adding.
 - Liquids should never be added to the dispenser.
 - Glacé (glazed) fruits such as cherries, ginger, pineapple, etc. should be washed and well-dried on a kitchen paper towel before adding into the dispenser. Sticky ingredients can also be tossed in a little flour to help with dispensing.
 - Bottled or canned ingredients such as olives, sun dried tomatoes etc. should be drained and well-dried on kitchen paper towel before adding to the dispenser.
 - It is recommended that the dispenser be cleaned thoroughly with a soft, damp cloth after each use.

4. The Fruit and Nut Dispenser will automatically release its contents on the BASIC, WHOLE WHEAT, SWEET, CONTINENTAL, DOUGH and GLUTEN FREE settings.



NOTE

The base of the dispenser will still open during the bread making cycle even when it is empty. This is normal.



TIP

If ingredients exceed the maximum $\frac{2}{3}$ cup capacity of the dispenser, do not use. Instead, open the lid and add ingredients manually.



NOTE

The fruit and nut dispenser opens automatically with all functions EXCEPT the following selections: French, Express 680g, Express 900g, Yeast Free, Jam, Bake and Yoghurt.

POWER INTERRUPTION PROTECTION

This bread maker is equipped with a 10-minute power interruption protection feature. If a power outage occurs while in operation and if the power is returned within 10 minutes, the bread maker will restart, continuing from the time that it stopped.



Hints & Tips

INGREDIENTS

Ensure you have a perfect loaf of bread by using fresh, quality ingredients and measuring them accurately.

The best results are obtained with flour that has at least 11-12% protein content, for this reason, all the recipes in this book use bread flour, with a protein content of 11-13%. This is normally stated on the packaging.

All-purpose Flour

Flour that contains no baking powder, suitable replacement for bread flour though will result in a doughier loaf.

Bread Flour

Bread flour is the most important ingredient of making bread and is recommended in most bread recipes. It has a high gluten content and can assist in keeping the bread from collapsing after rising.

Self-raising Flour

Flour that contains baking powder is used for yeast free breads and cake batters. Do not use self-raising flour in combination with yeast.

Whole-wheat Flour

Whole-wheat flour is ground from the entire wheat kernel. Bread made with, all or part whole-wheat flour will have higher fibre and nutritional content resulting in a smaller loaf and a heavier texture.

OTHER INGREDIENTS

Egg

Eggs provide liquid, help with raising and increase the nutritional value. They help with flavour, tenderness and colour and are usually used in sweeter bread types. Whisk eggs in with other liquid ingredients.

Salt

Salt is necessary to improve bread flavour and crust colour. Salt inhibits yeast activity so be careful when measuring as it should be accurate.

Fat

Fat adds flavour and retains moisture. Butter, margarine or vegetable oil can be used.

Sugar

Sugar provides food for yeast and increases the sweet taste and colour of the bread. White sugar, brown sugar, honey and maple syrup are all suitable to use. When using honey or golden syrup, it must be counted as additional liquid.

Water and Other Liquids (always added first)

Water is an essential ingredient for making bread. Water or other liquids should be tepid or warm. Extreme hot or cold water will prevent the yeast activating.

Yeast

Without yeast, the bread will not rise. Yeast needs liquid, sugar and warmth to grow and rise. Dried yeast has been used in all the recipes in this instruction booklet. Yeast is a living organism and should be kept in the refrigerator to remain fresh. Yeast needs carbohydrates found in sugar and flour as nourishment. Before using yeast, check the expiration date of the yeast.

Surebake*

Surebake is a mixture of active yeast and bread improver, commonly used in New Zealand. In some cases, the use of yeast will provide a better result than using a mixture of yeast and bread improver.

*Surebake may be a Trademark of its respective owners.



TIP

To check whether yeast is fresh and active:

1. Pour $\frac{1}{4}$ cup lukewarm tap water into a measuring cup.
2. Add 1 teaspoon white sugar and 1 teaspoon of yeast.
3. Place measuring cup in a warm place for about 10 minutes.
4. Fresh, active yeast will begin to bubble or “grow.” If it does not, the yeast is dead or inactive so will need to be discarded.

MEASURING & ORDER SEQUENCE

Measure each ingredient carefully and add to the bread pan in the exact order stated in the recipe.



IMPORTANT

Ensure all ingredients for making bread or dough are added in the exact order listed. Failing to do so may lead to a poor result and/or ingredients being expelled out of the bread pan.

Always add ingredients in order given in recipe.

FIRST: Liquid ingredients

SECOND: Dry ingredients

LAST: Yeast

Remember: The yeast should only be placed on dry flour and never come in contact with liquid, salt or sugar until kneading.

If setting the TIMER for a long delay, never add perishable ingredients such as eggs or milk.

Liquid Ingredients

Water, fresh milk, or other liquids should be measured with a glass measuring cup, clear markings and a spout. Set cup on counter and lower yourself to check the liquid level. When measuring cooking oil or other ingredients, clean measuring cup in between.

Fluid ml	Cup	Tablespoons	Teaspoons
250	1	16	48
175	$\frac{3}{4}$	12	36
125	$\frac{1}{2}$	8	24
60	$\frac{1}{4}$	4	12
		1	3
		$\frac{1}{2}$	$1\frac{1}{2}$

Dry Measurements

Measure dry ingredients by gently spooning flour, etc. into a measuring cup. Once filled, level-off with a knife. Do not tap bottom of the measuring cup or pack down.



HINT

Before measuring, sift flour to aerate. When measuring small amounts of dry ingredients, such as salt or sugar, use a measuring spoon, making sure it is levelled off. Weigh dry ingredients with a digital scale to provide more accurate measurements.

Dry Measurement Weight Equivalents

1 cup of:	Grams
All-purpose flour	120
Bread Flour	120
Whole-wheat flour	125
Rye flour	120

ABOUT INGREDIENTS

Can I use a sugar substitute in place of sugar?

Yes. Sugar is necessary for yeast to produce a light loaf with good height. Results may vary with the type and amount of sugar substitute used.

Can I omit salt from the recipe?

No. Salt plays a very important part in bread making. Omitting it will decrease water retention in the dough, as well as affect mixing, the strength of the gluten development and the fermentation of the yeast. In the finished bread, salt improves the loaf shape, crumb structure and crust colour, as well as extending shelf life and enhancing flavour.

Can I use my favourite bread recipes in my bread maker?

Yes, but you will need to experiment to get the correct portion of ingredients. Become familiar with the unit and make several loaves of bread with recipes provided before you begin experimenting. Never exceed a total amount of 4-5 cups of dry ingredients (that includes flours, oats, cornmeal, etc.). Use the recipes in this book to help determine the ratio of dry ingredients to liquid and amounts of yeast, sugar, salt, and fat to use.

ABOUT BAKING BREAD

Can I open the lid while the bread maker is operating?

This bread maker is designed with a window in the lid to let you watch your bread's progress. Quick checks are OK in early stages of kneading and to add ingredients. However, temperature in baking chamber adjusts for Rising and Baking stages. Opening the lid during these steps could cause the loaf to fall or not bake properly.

What will happen if I leave bread in the bread pan after baking?

This unit has a Keep Warm function that will keep the bread warm in the pan for up to 1 hour after baking is complete. Once Keep Warm is over, it is best to remove bread immediately or the bottom of the loaf may absorb moisture and become soggy.

Why does flour sometimes stick to the side of the bread?

During the 'knead' phase, small amounts of flour may sometimes stick to the sides of the bread pan and bake onto the sides of the loaf. Scrape the floured portion from the outer crust with a sharp knife. The next time you try the recipe, if necessary, during the 'knead 2' phase use a rubber spatula carefully to scrape in any unmixed flour from around the edges of the bread pan. This is especially important on the GLUTEN FREE and YEAST FREE settings.



Care, Cleaning & Storage

CLEANING THE HOUSING

- Wipe the exterior of the housing and the display screen with a soft, damp cloth. Do not use an abrasive cleanser or metal scouring pad to clean any part of the bread maker as these will scratch the surface.



WARNING

Never immerse the housing in water or place any part of the bread maker in the dishwasher. Take care not to allow water or cleaning fluids to seep under the buttons or the display screen on the control panel when wiping clean.

1. Ensure the bread maker is turned OFF by pressing and holding the START / CANCEL button for 3 seconds. Remove the power plug from the power outlet. Allow the bread maker and all accessories to cool completely before disassembling and cleaning.
2. If over-spills such as flour, nuts, raisins etc. occur in the interior baking chamber, allow the bread maker to completely cool before carefully removing them using a soft, damp cloth. Use extreme caution when cleaning the heating elements inside the baking chamber. Ensure the bread maker is completely cool then gently wipe with a soft, damp cloth. Do not use any type of cleanser or cleaning agent.

CLEANING THE LID

1. Open the lid & use a soft, damp sponge or cloth to clean the lid and dry thoroughly.

CLEANING THE FRUIT & NUT DISPENSER

1. The fruit and nut dispenser can be removed from the rear of the lid for cleaning.
2. Press and hold the latch upwards under the handle of the dispenser holder located on the rear of the lid. Pull out the dispenser holder and remove the base of the Fruit and Nut dispenser to clean.
3. Wash in warm soapy water and dry thoroughly before reassembling and returning to the bread maker.



NOTE

Never wash the fruit and nut dispenser in the dishwasher.

CLEANING THE BREAD PAN & KNEADING BLADE

The inside of the bread pan is coated with a high quality non-stick coating. As with any non-stick coated surface, do not use abrasive cleansers, metal scouring pads or metal utensils to clean these items as they may damage the finish. Never wash the bread pan in the dishwasher.

1. Remove the power plug from the power outlet. Allow the bread maker and all accessories to cool completely before disassembling and cleaning.
2. Remove the bread pan from the bread maker. If the kneading blade is still connected, remove from the pan.
3. Half fill the bread pan with warm soapy water and allow to stand for 10-20 minutes to loosen any food residue.



NOTE

A non-abrasive liquid cleanser or mild spray solution may be used. Do not scrub with an abrasive scourer or cleanser.

4. Wash the kneading blade in the soapy water in the pan. Allow to soak if required, to remove any food residue. Ensure there is no baked-on residue in the pan or on the blade, then rinse and dry thoroughly.
5. Wipe the outside of the bread pan with a damp cloth and dry thoroughly.
6. Ensure all parts are clean and dry prior to using.



WARNING

Do not immerse the outside of the bread pan in water as this may interfere with the free movement of the wingnut and drive shaft. Wipe with a soft, damp cloth only. Wash only the interior of the bread pan.



NOTE

Some discolouration may appear on, and inside the bread pan over time. This is a natural effect caused by moisture and steam and will not affect the bread in any way.



NOTE

Exposure to cooking oils and cleaning chemicals may cause colour fading and discolouration to the bread maker. If the bread maker is exposed to oils or chemicals, turn off and unplug the appliance, allow to cool and use a damp cloth to clean the surface of the bread maker. Dry thoroughly before use.

STORAGE

1. Ensure the bread maker is returned to the main menu by pressing and holding the START / CANCEL button for 3 seconds. Remove the power plug from the power outlet.
2. Ensure the bread maker and all accessories are completely cool, clean and dry.
3. Place the bread pan and kneading blade into the interior baking chamber.
4. Once assembled, close the lid of the bread maker.
5. Store the bread maker in an upright position on a flat, dry and level surface. Do not store anything on top of the bread maker.



WARNING

When moving the bread maker, allow the unit to fully cool down and carry the unit via the base.



NOTE

Use the provided measuring spoon when following the recipes included in this booklet.

If using the RAPID option increase the yeast amount by $\frac{1}{4}$ tsp or the Surebake by 1 tsp.



Recipes

TRADITIONAL WHITE BREAD

MENU 1 BASIC INGREDIENTS	AUS 450g	AUS 680g	AUS 900g	NZ 450g	NZ 680g	NZ 900g
Water	180ml	260ml	340ml	180ml	260ml	340ml
Olive oil	25ml	30ml	35ml	25ml	30ml	35ml
Salt	1 tsp.	1½ tsp.	1¾ tsp.	1 tsp.	1½ tsp.	1¾ tsp.
Sugar	1 tbsp.	1½ tbsp.	1¾ tbsp.	1 tbsp.	1½ tbsp.	1¾ tbsp.
Bread flour	300g	450g	590g	300g	450g	590g
Milk Powder	2 tsp.	1 tbsp.	1½ tbsp.	2 tsp.	1 t tbsp.	1½ tbsp.
Bread improver	1 tsp.	1½ tsp.	1¾ tsp.	-	-	-
Yeast	¾ tsp.	1 tsp.	1¼ tsp.	-	-	-
Surebake	-	-	-	1½ tsp.	2½ tsp.	3 tsp.

Method

1. Fit the bread pan with the kneading blade.
2. Place the ingredients into the bread pan in the listed order. Wipe any spills away from the outside of the pan.
3. Insert the bread pan into the bread maker and twist and lock into position. Close the lid.
4. Press the MENU button until MENU 1 (BASIC) is displayed on the screen.
5. Choose the CRUST COLOUR and LOAF SIZE.
6. Press START/CANCEL to commence the function.
7. After the function has completed, press START/CANCEL to stop the KEEP WARM setting.
8. Using oven mitts, remove the bread pan from the bread maker. Allow the bread to rest in the pan for 5 minutes before turning out to cool on a wire rack. Remove the kneading blade before slicing.

FRENCH BREAD

MENU 2 FRENCH INGREDIENTS	AUS 450g	AUS 680g	AUS 900g	NZ 450g	NZ 680g	NZ 900g
Water	200ml	300ml	340ml	200ml	300ml	340ml
Olive oil	5ml	10ml	15ml	5ml	10ml	15ml
Salt	1 tsp.	1½ tsp.	2 tsp.	1 tsp.	1½ tsp.	2 tsp.
Sugar	1 tsp.	1½ tsp.	2 tsp.	1 tsp.	1½ tsp.	2 tsp.
Bread flour	325g	450g	590g	325g	450g	590g
Bread improver	½ tsp.	¾ tsp.	¾ tsp.	-	-	-
Yeast	¾ tsp.	1 tsp.	1 tsp.	-	-	-
Surebake	-	-	-	1½ tsp.	2 tsp.	2½ tsp.

Method

1. Fit the bread pan with the kneading blade.
2. Place the ingredients into the bread pan in the listed order. Wipe any spills away from the outside of the pan.
3. Insert the bread pan into the bread maker and twist and lock into position. Close the lid.
4. Press the MENU button until MENU 2 (FRENCH) is displayed on the screen.
5. Choose the CRUST COLOUR and LOAF SIZE.
6. Press START/CANCEL to commence the function.
7. After the function has completed, press START/CANCEL to stop the KEEP WARM setting.
8. Using oven mitts, remove the bread pan from the bread maker. Allow the bread to rest in the pan for 5 minutes before turning out to cool on a wire rack. Remove the kneading blade before slicing.

WHOLE WHEAT BREAD

MENU 3 WHOLE- WHEAT INGREDIENTS	AUS 450g	AUS 680g	AUS 900g	NZ 450g	NZ 680g	NZ 900g
Water	190ml	270ml	360ml	190ml	270ml	360ml
Olive oil	15ml	30ml	40ml	15ml	30ml	40ml
Salt	¾ tsp.	1 tsp.	1 ½ tsp.	¾ tsp.	1 tsp.	1 ½ tsp.
Sugar	1 tbsp.	1 ¼ tbsp.	1 ¾ tbsp.	1 tbsp.	1 ¼ tbsp.	1 ¾ tbsp.
Whole-meal plain flour	300g	420g	560g	300g	420g	560g
Milk powder	¾ tbsp.	1 tbsp.	1 ½ tbsp.	¾ tbsp.	1 tbsp.	1 ½ tbsp.
Bread improver	½ tsp.	¾ tsp.	1 tsp.	-	-	-
Yeast	¾ tsp.	1 tsp.	1 ¼ tsp.	-	-	-
Surebake	-	-	-	2 tsp.	2 ½ tsp.	3 ½ tsp.

Method

1. Fit the bread pan with the kneading blade.
2. Place the ingredients into the bread pan in the listed order. Wipe any spills away from the outside of the pan.
3. Insert the bread pan into the bread maker and twist and lock into position. Close the lid.
4. Press the MENU button until MENU 3 (WHOLEWHEAT) is displayed on the screen.
5. Choose the CRUST COLOUR and LOAF SIZE.
6. Press START/CANCEL to commence the function.
7. After the function has completed, press START/CANCEL to stop the KEEP WARM setting.
8. Using oven mitts, remove the bread pan from the bread maker. Allow the bread to rest in the pan for 5 minutes before turning out to cool on a wire rack. Remove the kneading blade before slicing.

FRUIT & NUT BREAD

MENU 4 SWEET FRUIT AND & NUT INGREDIENTS	AUS 450g	AUS 680g	AUS 900g	NZ 450g	NZ 680g	NZ 900g
Water	140ml	210ml	275ml	140ml	210ml	275ml
Olive oil	25ml	40ml	50ml	25ml	40ml	50ml
Salt	¾ tsp.	1 tsp.	1 ¼ tsp.	¾ tsp.	1 tsp.	1 ¼ tsp.
Brown Sugar	25g.	40g	50g	25g	40g	50g
Bread flour	250g	370g	490g	250g	370g	490g
Milk powder	¾ tbsp.	1 tbsp.	1 ½ tbsp.	¾ tbsp.	1 tbsp.	1 ½ tbsp.
Bread improver	1/3 tsp.	½ tsp.	¾ tsp.	-	-	-
Ground mixed spice	½ tbsp.	¾ tbsp.	1 tbsp.	½ tbsp.	¾ tbsp.	1 tbsp.
Ground cinnamon	½ tbsp.	¾ tbsp.	1 tbsp.	½ tbsp.	¾ tbsp.	1 tbsp.
Yeast	¾ tsp.	1 tsp.	1 ¼ tsp.	-	-	-
Surebake	-	-	-	2 tsp.	2 ½ tsp.	3 ½ tsp.
Add dried fruit and nuts to the fruit and nut dispenser						
Dried fruit and nut mix	⅓ cup	½ cup	⅔ cup	⅓ cup	½ cup	⅔ cup

Method

1. Fit the bread pan with the kneading blade.
2. Place the ingredients into the bread pan in the listed order. Wipe any spills away from the outside of the pan.
3. Insert the bread pan into the bread maker and twist and lock into position. Close the lid.
4. Press the MENU button until MENU 4 (SWEET) is displayed on the screen.
5. Choose the CRUST COLOUR and LOAF SIZE.
6. Press START/CANCEL to commence the function.
7. After the function has completed, press START/CANCEL to stop the KEEP WARM setting.
8. Using oven mitts, remove the bread pan from the bread maker. Allow the bread to rest in the pan for 5 minutes before turning out to cool on a wire rack. Remove the kneading blade before slicing.

EXPRESS BREAD

MENU 5 EXPRESS 680G BASIC WHITE INGREDIENTS	AUS 680g	NZ 680g	MENU 6 EXPRESS 900G BASIC WHITE INGREDIENTS	AUS 900g	NZ 900g
Water	260ml	260ml	Water	340ml	340ml
Olive oil	30ml	30ml	Olive oil	35ml	35ml
Salt	1 ½ tsp.	1 ½ tsp.	Salt	1 ¾ tsp.	1 ¾ tsp.
Sugar	1 ½ tbsp.	1 ½ tbsp.	Sugar	2 tbsp.	2 tbsp.
Bread flour	450g	450g	Bread flour	590g	590g
Milk powder	1 tbsp.	1 tbsp.	Milk powder	1 ½ tbsp.	1 ½ tbsp.
Bread improver	2 tsp.	-	Bread improver	3 tsp.	-
Yeast	2 ¼ tsp.	-	Yeast	3 ¼ tsp.	-
Surebake	-	4 ½ tsp.	Surebake	-	6 tsp.

If using Surebake on the EXPRESS function, the Surebake is best dissolved in the water initially, as the yeast in the Surebake will not dissolve within the allocated time.

Method

1. Fit the bread pan with the kneading blade.
2. Place the ingredients into the bread pan in the listed order. Wipe any spills away from the outside of the pan.
3. Insert the bread pan into the bread maker and twist and lock into position. Close the lid.
4. Press the MENU button until MENU 5 (EXPRESS 680g) or MENU 6 (EXPRESS 900g) is displayed on the screen.
5. Press START/CANCEL to commence the function.
6. After the function has completed, press START/CANCEL to stop the KEEP WARM setting.
7. Using oven mitts, remove the bread pan from the bread maker. Allow the bread to rest in the pan for 5 minutes before turning out to cool on a wire rack. Remove the kneading blade before slicing.

YEAST FREE

MENU 7 YEAST FREE BANANA BREAD INGREDIENTS	AUS & NZ
Milk	80ml
Eggs, lightly beaten	2
Butter, melted	60g
Banana puree	250g
Brown sugar	250g
Bread flour	350g
Salt	½ tsp.
Baking powder	2 tsp.
Bi-carb soda	½ tsp.

Method

1. Fit the bread pan with the kneading blade.
2. Mix the wet ingredients and the dry ingredients separately.
3. Add the wet ingredients to the bread pan first, then add the dry ingredients. Close the lid.
4. Press MENU until MENU 7 (YEAST FREE) is displayed on the screen.
5. Press START/CANCEL to begin the function.
6. Scrape the sides of the bread pan using a silicon scraper during the initial knead stage.
7. After the function has completed, press START/CANCEL to stop the KEEP WARM setting.
8. Using oven mitts, remove the bread pan from the bread maker. Allow to rest in the pan for 5 minutes before turning out onto a wire rack. Remove kneading blade before slicing.

CONTINENTAL BREAD

MENU 8 CONTINENTAL INGREDIENTS	AUS	NZ
Water	315ml	315ml
Olive oil	15ml	15ml
Salt	1 ½ tsp.	1 ½ tsp.
Bread flour	560g	560g
Yeast	1 tsp.	-
Surebake	-	2 ½ tsp.

Method

1. Fit the bread pan with the kneading blade.
2. Place the ingredients into the bread pan in the listed order. Wipe any spills away from the outside of the pan.
3. Insert the bread pan into the bread maker and twist and lock into position. Close the lid.
4. Press the MENU button until MENU 8 (CONTINENTAL) is displayed on the screen.
5. Choose the CRUST COLOUR and LOAF SIZE.
6. Press START/CANCEL to commence the function.
7. After the function has completed, press START/CANCEL to stop the KEEP WARM setting.
8. Using oven mitts, remove the bread pan from the bread maker. Allow the bread to rest in the pan for 5 minutes before turning out to cool on a wire rack. Remove the kneading blade before slicing.

PIZZA DOUGH

MENU 9 DOUGH PIZZA DOUGH INGREDIENTS	AUS & NZ
Water	380ml
Olive oil	40ml
Salt	2 tsp.
Bread flour	570g
Yeast	1 ½ tsp.

Method

1. Fit the bread pan with the kneading blade.
2. Place the ingredients into the bread pan in the listed order. Wipe any spills away from the outside of the pan.
3. Insert the bread pan into the bread maker and twist and lock into position. Close the lid.
4. Press the MENU button until MENU 9 (DOUGH) is displayed on the screen.
5. Press START/CANCEL to commence the function.
6. After the function has completed, remove the bread pan from the bread maker. Remove the dough from the bread pan and place onto a lightly floured bench. Remove the kneading blade from the dough.
7. Use as desired.

GLUTEN FREE WHITE BREAD

MENU 10
GLUTEN FREE
WHITE BREAD
INGREDIENTS

AUS
& NZ

WET INGREDIENTS	
Water	380ml
Olive oil	40ml
Eggs	2 tsp.
White vinegar	570g
DRY INGREDIENTS	
White rice flour	220g
Brown rice flour	100g
Besan flour	35g
Arrowroot	75g
Xanthum gum	2 tsp.
Caster sugar	2 tsp.
Salt	1 tsp.
Yeast	2 tsp.



NOTE

Surebake is not gluten-free.

Method

1. Mix together the wet ingredients and the dry ingredients separately.
2. Fit the bread pan with the kneading blade.
3. Add the wet ingredients to the bread pan first and then the dry ingredients.
4. Place the bread pan into the bread maker and twist and lock in position. Close the lid.
5. Press the GLUTEN FREE short cut button OR press the MENU button until MENU 10 (GLUTEN FREE) is displayed on the screen.
6. Press START/CANCEL to begin.
7. Scrape the sides of the bread pan using a silicon scraper during the initial knead stage.
8. Using oven mitts, remove the bread pan from the bread maker. Allow the bread to rest in the pan for 5 minutes before turning out to cool on a wire rack. Remove the kneading blade before slicing.

STRAWBERRY, RHUBARB & ACAI JAM

MENU 11
JAM - STRAWBERRY,
RHUBARB AND ACAI
INGREDIENTS

AUS
& NZ

Rhubarb, cut into 1cm pieces	140g
Strawberry 1/4's	170g
Caster sugar	240g
Lemon zest	1/8 tsp.
Jamsetta	1 tsp.
Vanilla paste	1/2 tsp.
Acai powder	1 tsp.

Method

1. Wash and dry the rhubarb and strawberries well and cut them into 1cm pieces.
2. Fit the bread pan with the kneading blade. Place the ingredients into the bread pan.
3. Press the MENU button until MENU 11 (JAM) is displayed on the screen.
4. Press the START/CANCEL button to begin.
5. The bread maker will beep 10 times at completion. Allow to cool before serving.



NOTE

The Jam will be extremely hot - take care when handling the bread pan with jam.



NOTE

Sterilise jars prior to filling to extend the life of the jam. All ingredients in total, should not exceed 2 cups as this may cause overflow.

YOGHURT

MENU 13
YOGHURT
VANILLA YOGHURT
INGREDIENTS

AUS
& NZ

Full cream milk	1L
Caster sugar	2 tbsp.
Vanilla essence	½ tsp.
Natural yoghurt	⅓ cup
Full cream milk powder	50g

Method

1. Sterilise all equipment to be used in yoghurt making.
2. In a medium saucepan, place the milk and sugar. Heat the milk to be 80°C and then allow to cool to 40°C.
3. Once the milk has cooled to 40°C, add the vanilla, yoghurt and milk powder to the milk and whisk well.
4. Place the mixture into the bread pan (with no kneading blade), place the bread pan into the bread maker and twist and lock into position. Close the lid.
5. Press the MENU button until MENU 13 (YOGHURT) is displayed on the screen.
6. Press the START/CANCEL button to begin.
7. Remove the bread pan and place the pan in the fridge to cool. Spoon into desired storage ware and keep in the fridge for up to 1 week.



TIP

The mixture can be placed into the bread pan in sterilized jars for pot set yoghurt – be sure the jars are clean and sterilized. Be wary that the hard surface of the jars may scratch the bread pan non-stick surface – place a layer of silicon in the bottom to prevent scratching.



NOTE

If using jars for pot set yoghurt, do not put the lids on the jars until they are cooled. Store in the fridge for up to 1 week.



Troubleshooting

POSSIBLE PROBLEM	POSSIBLE REASON	EASY SOLUTION
Smoke comes out of the baking chamber during baking.	<ul style="list-style-type: none">• Flour or other ingredients have spilled into baking chamber.	<ul style="list-style-type: none">• Stop bread maker, switch it off and unplug at the power outlet. Allow bread maker to cool completely. Wipe excess flour, etc., from baking chamber with a damp cloth. <p>TIP: Measure ingredients on the kitchen counter, adding them to the bread pan prior to inserting the bread pan into the bread maker.</p>
The middle of the baked bread has sunken and the bottom of the crust is thick.	<ul style="list-style-type: none">• Ingredients have been placed into the bread pan in the incorrect order. Ingredients have been substituted and have not been effective.	<ul style="list-style-type: none">• Remove the bread from the bread pan in a timely fashion.
The baked bread is difficult to remove from the bread pan.	<ul style="list-style-type: none">• The kneading blade is stuck on the drive shaft.	<ul style="list-style-type: none">• Remove the bread pan from the bread maker and invert the bread pan and give a tap on a chopping board to assist in the removal of the bread from the bread pan. Once the bread is removed, soak the bread pan in hot water for 10 minutes. Remove the kneading blade from the bread pan and clean.
The ingredients are not blending through and the bread has not baked well.	<ul style="list-style-type: none">• Wrong program selected• Too many dry ingredients• Once the program has started, the lid was opened a number of times and program interrupted.• The ingredients were placed into the bread pan in the incorrect order.	<ul style="list-style-type: none">• Check whether the recipe is appropriate for the program chosen.• Make sure ingredients are measured accurately and added in the proper order. Use a rubber spatula to scrape sides of pan while bread baker is mixing to ensure all ingredients are blended.• Keep the lid closed during the last cycle.• Check the kneading blade for any damage.
Abnormal noise.	<ul style="list-style-type: none">• The bread pan is not placed properly inside the bread maker.• The dough is too large to stir	<ul style="list-style-type: none">• Ensure the dough is prepared correctly. Reduce quantities of ingredients if required.

POSSIBLE PROBLEM	POSSIBLE REASON	EASY SOLUTION
The fermented volume of the bread is too large causing the lid to open.	<ul style="list-style-type: none"> • Too much yeast, flour or water has been added. 	<ul style="list-style-type: none"> • Appropriately reduce the ingredients.
The fermented dough collapsed in the middle after baking.	<ul style="list-style-type: none"> • Bread flour was not used. The flour used has low protein. • Too much water, too wet dough and too soft. 	<ul style="list-style-type: none"> • Use a different flour. • Use ingredients at room temperature. • Reduce the water in the ingredients.
The bread is heavy and dense.	<ul style="list-style-type: none"> • There is too much flour and not enough water. • There is too much fruit or whole wheat flour. 	<ul style="list-style-type: none"> • Reduce flour and increase water. • Reduce the amount of corresponding ingredients and increase yeast.
There are too many holes in the baked bread.	<ul style="list-style-type: none"> • There is too much water and no salt. • The water temperature is too high. 	<ul style="list-style-type: none"> • Check the water temperature.
There is dry powder on the surface of the bread.	<ul style="list-style-type: none"> • Ingredients are being used that are dissolvable or with strong viscosity. E.g. Butter, bananas etc. • Insufficient mixing & too little water. 	<ul style="list-style-type: none"> • Check if the amount of water is appropriate. • Check if the mixing mechanism is abnormal during operation.
When baking cakes or food with a lot of sugar, the crust is too dark and too thick.	<ul style="list-style-type: none"> • Different formulas and ingredients have a great influence on the burning colour. 	<ul style="list-style-type: none"> • Stop the program 5 – 10 minutes before completion. Wait for 20 minutes before opening the lid.
Beeping and E00 on LCD screen.	<ul style="list-style-type: none"> • The ambient temperature is too low. 	<ul style="list-style-type: none"> • Use the bread maker at room temperature.
Beeping and E01 on LCD screen.	<ul style="list-style-type: none"> • The bread maker has not cooled down after previous baking cycle and its interior will still be warm. 	<ul style="list-style-type: none"> • Unplug the bread maker, take out the bread pan and let the bread maker cool down to room temperature before using again.
Beeping and EEE on LCD screen.	<ul style="list-style-type: none"> • There is a problem with the circuit. 	<ul style="list-style-type: none"> • Switch the unit off and contact the Breville Customer Service Centre.
Beeping and HHH on LCD screen.	<ul style="list-style-type: none"> • There is a problem with the circuit. 	<ul style="list-style-type: none"> • Switch the unit off and contact the Breville Customer Service Centre.



Notes

Breville Customer Service Centre

Australian Customers

Phone: 1300 139 798

Fax: (02) 9700 1342

Web: www.breville.com

New Zealand Customers

Phone: 0800 273 845

Fax: 0800 288 513

Web: www.breville.com

Breville®

Master Every Moment™

Breville, the Breville logo, Master Every Moment and the Baker's Dozen are registered trademarks of Breville Pty. Ltd. A.B.N. 98 000 092 928.

Copyright Breville Pty. Ltd. 2019. All other brands may be trademarks of their respective owners.

Due to continued product improvement, the products illustrated/photographed in this booklet may vary slightly from the actual product.